

JEE (MAIN)-2013

Date : 07-04-2013

Duration : 3 Hours

Max. Marks : 360

IMPORTANT INSTRUCTIONS

1. Immediately fill the particulars on this page of the Test Booklet with Blue / Black Ball Point Pen. Use of pencil is strictly prohibited.
2. The Answer Sheet is kept inside this Test Booklet. When you are directed to open the Test Booklet, take out the Answer Sheet and fill in the particulars carefully.
3. The test is of **3 hours** duration.
4. The Test Booklet consists of **90** questions. The maximum marks are **360**.
5. There are three parts in the question paper A, B, C consisting of **Physics, Chemistry and Mathematics** having 30 questions in each part of equal weightage. Each question is allotted **4 (four)** marks for correct response.
6. *Candidates will be awarded marks as stated above in Instructions No. 5 for correct response of each question. $\frac{1}{4}$ (one fourth) marks will be deducted for indicating incorrect response of each question. No deduction from the total score will be made if no response is indicated for an item in the answer sheet.*
7. There is only one correct response for each question. Filling up more than one response in any question will be treated as wrong response and marks for wrong response will be deducted accordingly as per instructions 6 above.
8. Use **Blue/Black Ball Point Pen only** for writing particulars/markings responses on **Side-1** and **Side-2** of the Answer Sheet. **Use of pencil is strictly prohibited.**
9. No candidate is allowed to carry any textual material, printed or written, bits of papers, paper, mobile phone, any electronic device, etc., except the Admit Card inside the examination hall/room.
10. Rough work is to be done on the space provided for this purpose in the Test Booklet only. This space is given at the bottom of each page and in 3 pages at the end of the booklet.
11. On completion of the test, the candidate must hand over the Answer Sheet to the Invigilator on duty in the Room/Hall. However, the candidates are allowed to take away this Test Booklet with them.
12. The CODE for this Booklet is **P**. Make sure that the CODE printed on **Side-2** of the Answer Sheet is the same as that on this booklet. In case of discrepancy, the candidate should immediately report the matter to the Invigilator for replacement of both the Test Booklet and the Answer Sheet.
13. **Do not fold or make any stray marks on the Answer Sheet.**

Name of the Candidate (in Capital letters) : _____

Roll Number : in figures :

--	--	--	--	--	--	--	--

 in words : _____

Examination Centre Number :

--	--	--	--	--	--

Name of Examination Centre (in Capital letters) : _____

Candidate's Signature : _____ Invigilator's Signature : _____

PART A – PHYSICS

1. A uniform cylinder of length L and mass M having cross-sectional area A is suspended, with its length vertical, from a fixed point by a massless spring such that it is half submerged in a liquid of density σ at equilibrium position. The extension x_0 of the spring when it is in equilibrium is :

(1) $\frac{Mg}{k}$ (2) $\frac{Mg}{k} \left(1 - \frac{LA\sigma}{M}\right)$ (3) $\frac{Mg}{k} \left(1 - \frac{LA\sigma}{2M}\right)$ (4) $\frac{Mg}{k} \left(1 + \frac{LA\sigma}{M}\right)$

Sol. $kx_0 + F_B = mg$

$$kx_0 + \sigma \frac{L}{2} Ag = Mg$$

$$x_0 = \frac{Mg - \frac{\sigma LA g}{2}}{k}$$

$$= \frac{Mg}{k} \left(1 - \frac{\sigma LA}{2M}\right)$$

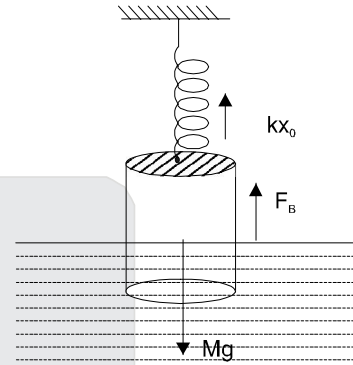

Ans (3)

2. A metallic rod of length ' l ' is tied to a string of length $2l$ and made to rotate with angular speed ω on a horizontal table with one end of the string fixed. If there is a vertical magnetic field ' B ' in the region, the e.m.f. induced across the ends of the rod is:

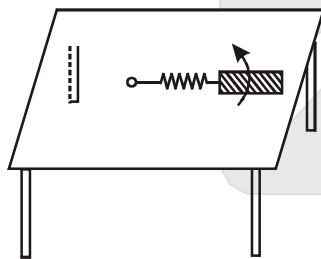

(1) $\frac{2B\omega l^2}{2}$ (2) $\frac{3B\omega l^2}{2}$ (3) $\frac{4B\omega l^2}{2}$ (4) $\frac{5B\omega l^2}{2}$

Sol.
$$e = \int_{2\ell}^{3\ell} (\omega x) B dx = B\omega \frac{[(3\ell)^2 - (2\ell)^2]}{2}$$

$$= \frac{5B\ell^2\omega}{2}$$

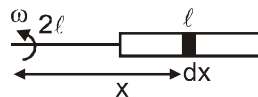

Ans. (4)

3. This question has statement I and Statement II. Of the four choices given after the Statements, choose the one that best describes the two Statements.

Statement - I : A point particle of mass m moving with speed v collides with stationary point particle of mass

M . If the maximum energy loss possible is given as $f\left(\frac{1}{2}mv^2\right)$ then $f = \left(\frac{m}{M+m}\right)$.

Statement - II : Maximum energy loss occurs when the particles get stuck together as a result of the collision.

- (1) Statement -I is true, Statment -II is true, Statement -II is the correct explanation of Statement -I.
 (2) Statement -I is true, Statment - II is true, Statement - II is not the correct explanation of Statement - I.
 (3) Statement -I is true, Statment - II is false.
 (4) Statement -I is false, Statment - II is true.

Sol. Maximum energy loss = $\frac{P^2}{2m} - \frac{P^2}{2(m+M)}$

$$= \frac{P^2}{2m} \left[\frac{M}{(m+M)} \right] = \frac{1}{2}mv^2 \left\{ \frac{M}{m+M} \right\} \quad \left(f = \frac{M}{m+M} \right)$$

Hence Statement -1 is wrong and statement 2 is correct Hence

Ans (4)

4. Let $[\epsilon_0]$ denote the dimensional formula of the permittivity of vacuum. If $M =$ mass, $L =$ length, $T =$ time and $A =$ electric current, then :

(1) $[\epsilon_0] = [M^{-1} L^{-3} T^2 A]$

(2) $[\epsilon_0] = [M^{-1} L^{-3} T^4 A^2]$

(3) $[\epsilon_0] = [M^{-1} L^2 T^{-1} A^{-2}]$

(4) $[\epsilon_0] = [M^{-1} L^2 T^{-1} A]$

Sol. $F = \frac{1}{4\pi\epsilon_0} \frac{q_1q_2}{R^2}$

$$\epsilon_0 = \frac{q_1q_2}{4\pi FR^2}$$

$$\text{Hence } \epsilon_0 = \frac{C^2}{N \cdot m^2} = \frac{[AT]^2}{MLT^{-2} \cdot L^2} = [M^{-1} L^{-3} T^4 A^2]$$

Ans. (2)

5. A projectile is given an initial velocity of $(\hat{i} + 2\hat{j})$ m/s, where \hat{i} is along the ground and \hat{j} is along the vertical.

If $g = 10 \text{ m/s}^2$, the equation of its trajectory is :

(1) $y = x - 5x^2$

(2) $y = 2x - 5x^2$

(3) $4y = 2x - 5x^2$

(4) $4y = 2x - 25x^2$

Sol. $\vec{v} = \hat{i} + 2\hat{j}$

$\Rightarrow x = t$... (i)

$y = 2t - \frac{1}{2}(10t^2)$... (ii)

From (i) and (ii)

$y = 2x - 5x^2$

Hence Ans (2)

6. The amplitude of a damped oscillator decreases to 0.9 times its original magnitude in 5s. In another 10s it will decrease to α times its original magnitude, where α equals.

(1) 0.7 (2) 0.81 (3) 0.729 (4) 0.6

Sol. $A = A_0 e^{-\frac{bt}{2m}}$

after 5 second

$$0.9A_0 = A_0 e^{-\frac{b(5)}{2m}} \quad \dots(i)$$

After 10 more second

$$A = A_0 e^{-\frac{b(15)}{2m}} \quad \dots(ii)$$

From (i) & (ii)

$$A = 0.729 A_0 \quad \text{Hence Ans. (3)}$$

7. Two capacitors C_1 and C_2 are charged to 120 V and 200 V respectively. It is found that by connecting them together the potential on each one can be made zero. Then :

(1) $5C_1 = 3C_2$ (2) $3C_1 = 5C_2$ (3) $3C_1 + 5C_2 = 0$ (4) $9C_1 = 4C_2$

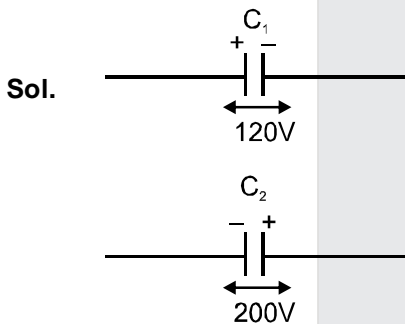

For potential to be made zero, after connection

$$120C_1 = 200C_2$$

$$\Rightarrow 3C_1 = 5C_2$$

Ans. (2)

8. A sonometer wire of length 1.5 m is made of steel. The tension in it produces an elastic strain of 1%. What is the fundamental frequency of steel if density and elasticity of steel are $7.7 \times 10^3 \text{ kg/m}^3$ and $2.2 \times 10^{11} \text{ N/m}^2$ respectively ?

(1) 188.5 Hz (2) 178.2 Hz (3) 200.5 Hz (4) 770 Hz

Sol. $f = \frac{v}{2\ell} = \frac{1}{2\ell} \sqrt{\frac{T}{\mu}} = \frac{1}{2\ell} \sqrt{\frac{T}{Ad}}$

$$\text{Also } Y = \frac{T\ell}{A\Delta\ell} \Rightarrow \frac{T}{A} = \frac{Y\Delta\ell}{\ell} \Rightarrow f = \frac{1}{2\ell} \sqrt{\frac{y\Delta\ell}{\ell d}}$$

$$\ell = 1.5\text{m}, \frac{\Delta\ell}{\ell} = 0.01, d = 7.7 \times 10^3 \text{ kg/m}^3$$

$$y = 2.2 \times 10^{11} \text{ N/m}^2$$

After solving

$$f = \sqrt{\frac{2}{7}} \times \frac{10^3}{3} \text{ Hz}$$

$$f \approx 178.2 \text{ Hz}$$

Ans. (2)

9. A circular loop of radius 0.3 cm lies parallel to a much bigger circular loop of radius 20 cm. The centre of the small loop is on the axis of the bigger loop. The distance between their centres is 15 cm. If a current of 2.0 A flows through the smaller loop, then the flux linked with bigger loop is :
- (1) 9.1×10^{-11} weber (2) 6×10^{-11} weber
 (3) 3.3×10^{-11} weber (4) 6.6×10^{-9} weber

Sol.
$$\frac{\mu_0 (2)(20 \times 10^{-2})^2}{2[(0.2)^2 + (0.15)^2]} \times \pi (0.3 \times 10^{-2})^2$$

on solving
 $= 9.216 \times 10^{-11}$
 $\approx 9.2 \times 10^{-11}$ weber

Ans (1)

10. Diameter of a plano - convex lens is 6 cm and thickness at the centre is 3 mm. If speed of light in material of lens is 2×10^8 m/s, the focal length of the lens is :
- (1) 15 cm (2) 20 cm (3) 30 cm (4) 10 cm

Sol.
$$n = \frac{3}{2}$$

$$3^2 + (R - 3\text{mm})^2 = R^2$$

$$\Rightarrow 3^2 + R^2 - 2R(3\text{mm}) + (3\text{mm})^2 = R^2$$

$$\Rightarrow R \approx 15 \text{ cm}$$

$$\frac{1}{f} = \left(\frac{3}{2} - 1\right) \left(\frac{1}{15}\right) \Rightarrow f = 30 \text{ cm}$$

Ans (3)

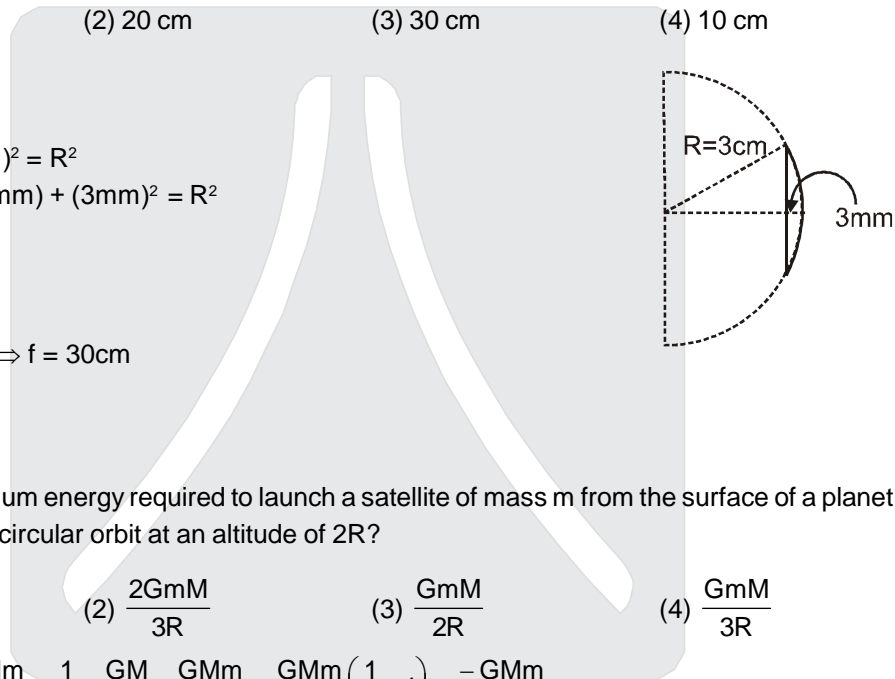

11. What is the minimum energy required to launch a satellite of mass m from the surface of a planet of mass M and radius R in a circular orbit at an altitude of $2R$?

- (1) $\frac{5GMm}{6R}$ (2) $\frac{2GMm}{3R}$ (3) $\frac{GMm}{2R}$ (4) $\frac{GMm}{3R}$

Sol.
$$E_f = \frac{1}{2}mv_0^2 - \frac{GMm}{3R} = \frac{1}{2}m \frac{GM}{3R} - \frac{GMm}{3R} = \frac{GMm}{3R} \left(\frac{1}{2} - 1\right) = -\frac{GMm}{6R}$$

$$E_i = \frac{-GMm}{R} + K$$

$$E_i = E_f$$

$$K = \frac{5GMm}{6R}$$

Ans (1)

12. A diode detector is used to detect an amplitude modulated wave of 60% modulation by using a condenser of capacity 250 pico farad in parallel with a load resistance 100 kilo ohm. Find the maximum modulated frequency which could be detected by it.
 (1) 10.62 MHz (2) 10.62 kHz (3) 5.31 MHz (4) 5.31 kHz

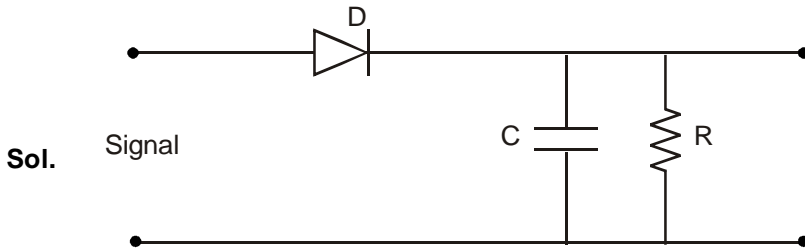

$$\begin{aligned} \tau = RC &= 100 \times 10^3 \times 250 \times 10^{-12} \text{ sec} \\ &= 2.5 \times 10^7 \times 10^{-12} \text{ sec} \\ &= 2.5 \times 10^{-5} \text{ sec} \end{aligned}$$

The higher frequency which can be detected with tolerable distortion is

$$\begin{aligned} f &= \frac{1}{2\pi m_a RC} = \frac{1}{2\pi \times 0.6 \times 2.5 \times 10^{-5}} \text{ Hz} \\ &= \frac{100 \times 10^4}{25 \times 1.2\pi} \text{ Hz} \\ &= \frac{4}{1.2\pi} \times 10^4 \text{ Hz} \\ &= 10.61 \text{ KHz} \end{aligned}$$

This condition is obtained by applying the condition that rate of decay of capacitor voltage must be equal or less than the rate of decay modulated signal voltage for proper detection of modulated signal.

Ans (2)

13. A beam of unpolarised light of intensity I_0 is passed through a polaroid A and then through another polaroid B which is oriented so that its principal plane makes an angle of 45° relative to that of A. The intensity of the emergent light is :
 (1) I_0 (2) $I_0/2$ (3) $I_0/4$ (4) $I_0/8$

Sol. Relation between intensities is

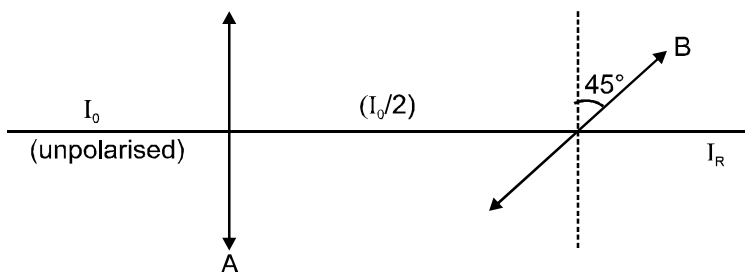

$$I_R = \left(\frac{I_0}{2} \right) \cos^2 (45^\circ) = \frac{I_0}{2} \times \frac{1}{2} = \frac{I_0}{4}$$

Ans. (3)

14. The supply voltage to room is 120 V. The resistance of the lead wires is 6 Ω . A 60 W bulb is already switched on. What is the decrease of voltage across the bulb, when a 240 W heater is switched on in parallel to the bulb ?
- (1) zero Volt (2) 2.9 Volt
 (3) 13.3 Volt (4) 10.04 Volt

Sol.

$$P = \frac{V^2}{R}$$

$$R = \frac{120 \times 120}{60} = 240 \Omega$$

$$R_{eq.} = 240 + 6 = 246 \Omega$$

$$V_1 = \frac{240}{246} \times 120 = 117.073 \text{ volt}$$

$$V_2 = \frac{48}{54} \times 120 = 106.66 \text{ Volt}$$

$$V_1 - V_2 = 10.04 \text{ Volt}$$

Ans (4)

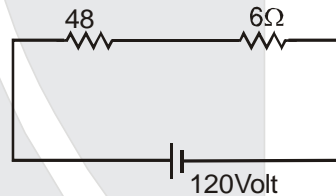
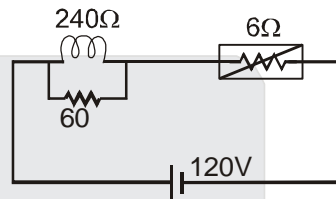
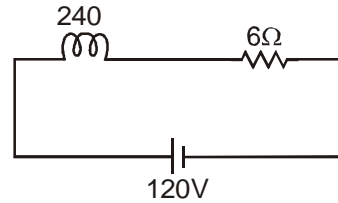

15.

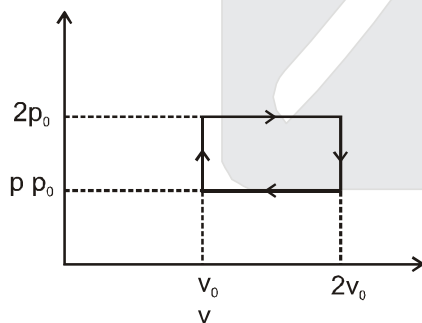

The above p-v diagram represents the thermodynamic cycle of an engine, operating with an ideal monoatomic gas. The amount of heat, extracted from the source in a single cycle is :

- (1) $p_0 v_0$ (2) $\left(\frac{13}{2}\right) p_0 v_0$ (3) $\left(\frac{11}{2}\right) p_0 v_0$ (4) $4p_0 v_0$

Sol.

$$\frac{3}{2} P_0 V_0 + \frac{5}{2} 2P_0 V_0$$

$$= \frac{13}{2} P_0 V_0$$

Ans (2)

16. A hoop of radius r and mass m rotating with an angular velocity ω_0 is placed on a rough horizontal surface. The initial velocity of the centre of the hoop is zero. What will be the velocity of the centre of the hoop when it ceases to slip ?

- (1) $\frac{r\omega_0}{4}$ (2) $\frac{r\omega_0}{3}$ (3) $\frac{r\omega_0}{2}$ (4) $r\omega_0$

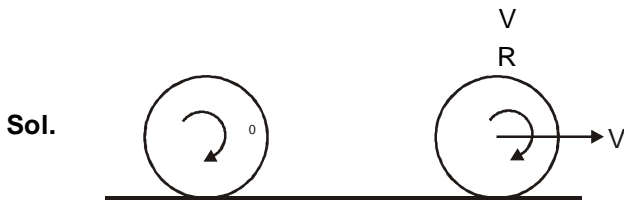

$$mr^2\omega_0 = mvr + mr^2 \times \frac{v}{r}$$

$$\Rightarrow v = \frac{\omega_0 r}{2}$$

Ans (3)

17. An ideal gas enclosed in a vertical cylindrical container supports a freely moving piston of mass M . The piston and the cylinder have equal cross sectional area A . When the piston is in equilibrium, the volume of the gas is V_0 and its pressure is P_0 . The piston is slightly displaced from the equilibrium position and released. Assuming that the system is completely isolated from its surrounding, the piston executes a simple harmonic motion with frequency :

- (1) $\frac{1}{2\pi} \frac{A\gamma P_0}{V_0 M}$ (2) $\frac{1}{2\pi} \frac{V_0 M P_0}{A^2 \gamma}$ (3) $\frac{1}{2\pi} \sqrt{\frac{A^2 \gamma P_0}{M V_0}}$ (4) $\frac{1}{2\pi} \sqrt{\frac{M V_0}{A \gamma P_0}}$

Sol.

$$\frac{Mg}{A} = P_0$$

$$Mg = P_0 A \dots\dots\dots(1)$$

$$P_0 V_0^\gamma = P V^\gamma$$

$$P_0 A x_0^\gamma = P A (x_0 - x)^\gamma$$

$$P = \frac{P_0 x_0^\gamma}{(x_0 - x)^\gamma}$$

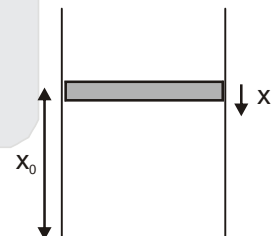

let piston is displaced by x

$$Mg - \left(\frac{P_0 x_0^\gamma}{(x_0 - x)^\gamma} \right) A = F_{\text{restoring}}$$

$$P_0 A \left(1 - \frac{x_0^\gamma}{(x_0 - x)^\gamma} \right) = F_{\text{restoring}} \quad [x_0 - x \approx x_0]$$

$$F = - \frac{\gamma P_0 A x}{x_0}$$

$$\therefore f = \frac{1}{2\pi} \sqrt{\frac{\gamma P_0 A}{x_0 M}}$$

$$= \frac{1}{2\pi} \sqrt{\frac{\gamma P_0 A^2}{M V_0}}$$

Ans (3)

18. If a piece of metal is heated to temperature θ and then allowed to cool in a room which is at temperature θ_0 , the graph between the temperature T of the metal and time t will be closest to :

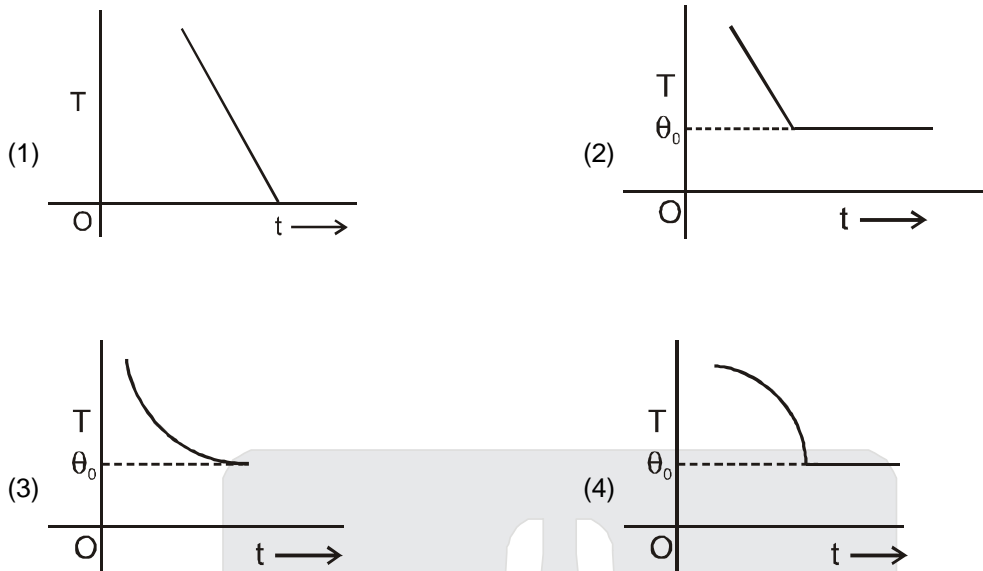

Sol. According to Newton's cooling law option **(3)** is correct Answer.

19. This question has Statement I and Statement II. Of the four choices given after the Statements, choose the one that best describes the two Statements.

Statement - I : Higher the range, greater is the resistance of ammeter.

Statement - II : To increase the range of ammeter, additional shunt needs to be used across it.

- (1) Statement - I is true, Statement - II is true, Statement - II is the correct explanation of Statement - I.
 (2) Statement - I is true, Statement - II is true, Statement - II is not the correct explanation of Statement - I.
 (3) Statement - I is true, Statement - II is false.
 (4) Statement - I is false, Statement - II is true.

Sol. Statement I is false and Statement II is true

Ans (4)

20. In an LCR circuit as shown below both switches are open initially. Now switch S_1 is closed, S_2 kept open. (q is charge on the capacitor and $\tau = RC$ is Capacitive time constant). Which of the following statements is correct ?

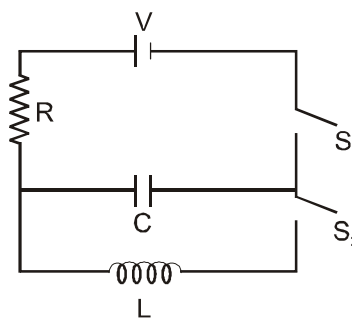

- (1) Work done by the battery is half of the energy dissipated in the resistor
 (2) At $t = \tau$, $q = CV/2$
 (3) At $t = 2\tau$, $q = CV (1 - e^{-2})$
 (4) At $t = \frac{\tau}{2}$, $q = CV (1 - e^{-1})$

Sol. $q = CV (1 - e^{-t/\tau})$
 at $t = 2\tau$
 $q = CV (1 - e^{-2})$
Ans (3)

21. Two coherent point sources S_1 and S_2 are separated by a small distance 'd' as shown. The fringes obtained on the screen will be :

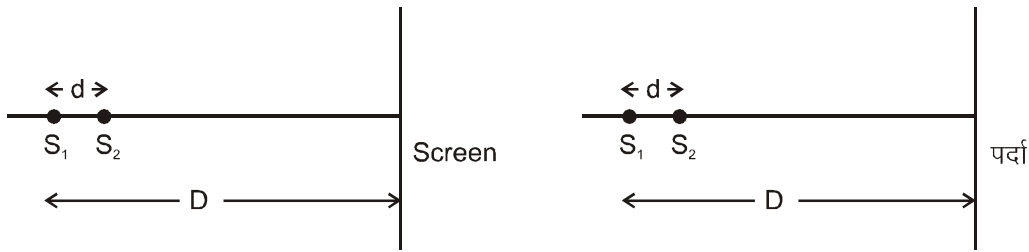

- (1) points
- (2) straight lines
- (3) semi-circles
- (4) concentric circles

Sol. It will be concentric circles
Ans (4)

22. The magnetic field in a travelling electromagnetic wave has a peak value of 20 nT. The peak value of electric field strength is :
 (1) 3V/m (2) 6V/m (3) 9V/m (4) 12 V/m

Sol. $\vec{E} = \vec{B} \times \vec{C}$
 $|\vec{E}| = |\vec{B}| \cdot |\vec{C}| = 20 \times 10^{-9} \times 3 \times 10^8$
 $= 6 \text{ V/m.}$
Ans (2)

23. The anode voltage of a photocell is kept fixed. The wavelength λ of the light falling on the cathode is gradually changed. The plate current I of the photocell varies as follows :

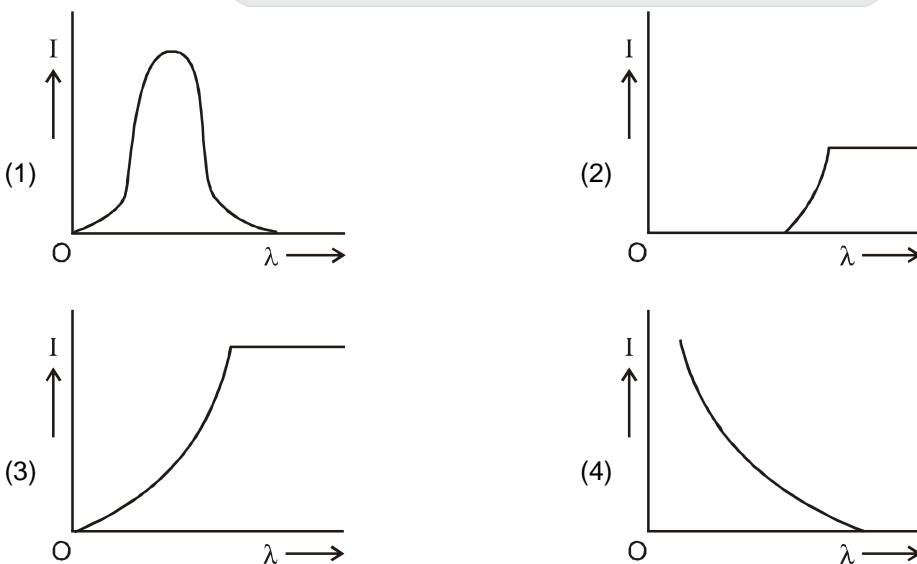

Sol. As λ is increased, there will be a value of λ above which photoelectrons will be cease to come out so photocurrent will become zero. Hence (4) is correct answer.
Ans (4)

24. The I – V characteristic of an LED is :

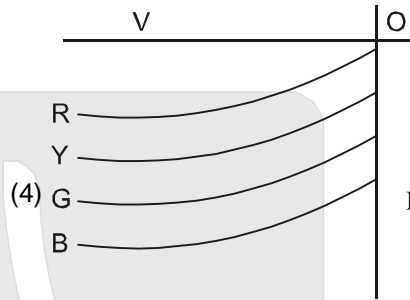
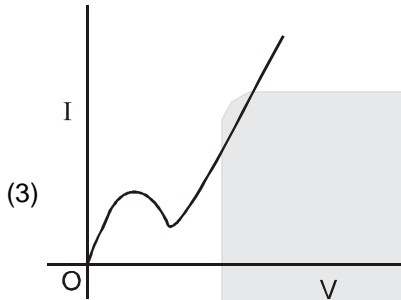
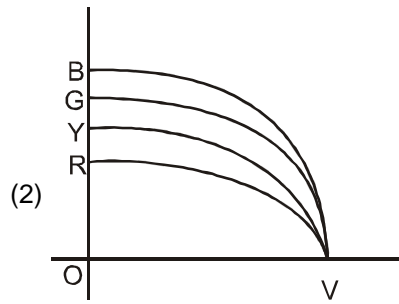
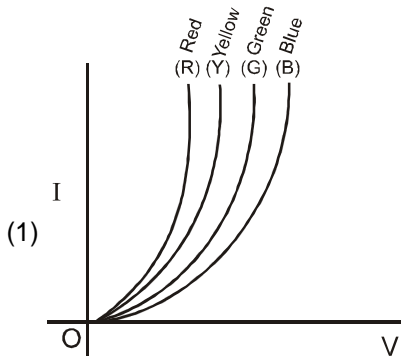

Sol. For same value of current higher value of voltage is required for higher frequency hence (1) should be correct answers.

Ans (1)

25. Assume that a drop of liquid evaporates by decrease in its surface energy, so that its temperature remains unchanged. What should be the minimum radius of the drop for this to be possible ? The surface tension is T , density of liquid is ρ and L is its latent heat of vaporization.

- (1) $\rho L/T$ (2) $\sqrt{T/\rho L}$ (3) $T/\rho L$ (4) $2T/\rho L$

Sol. When radius is decrease by dr
decrease in surface energy = Heat required for vaporisation

$$(4\pi r dr) \times T \times 2 = 4\pi r^2 dr \rho \quad \Rightarrow r = \frac{2T}{\rho L}$$

Ans. (4)

26. In a hydrogen like atom electron make transition from an energy level with quantum number n to another with quantum number $(n-1)$. If $n \gg 1$, the frequency of radiation emitted is proportional to :

- (1) $\frac{1}{n}$ (2) $\frac{1}{n^2}$ (3) $\frac{1}{n^{3/2}}$ (4) $\frac{1}{n^3}$

Sol. $\Delta E = h\nu$

$$\nu = \frac{\Delta E}{h} = k \left[\frac{1}{(n-1)^2} - \frac{1}{n^2} \right] = \frac{k2n}{n^2(n-1)^2}$$

$$\approx \frac{2k}{n^3} \propto \frac{1}{n^3}$$

Ans. (4)

27. The graph between angle of deviation (δ) and angle of incidence (i) for a triangular prism is represented by :



Sol. Ans. (3)

28. Two charges, each equal to q , are kept at $x = -a$ and $x = a$ on the x -axis. A particle of mass m and charge $q_0 = \frac{q}{2}$ is placed at the origin. If charge q_0 is given a small displacement ($y \ll a$) along the y -axis, the net force acting on the particle is proportional to :

- (1) y (2) $-y$ (3) $\frac{1}{y}$ (4) $-\frac{1}{y}$

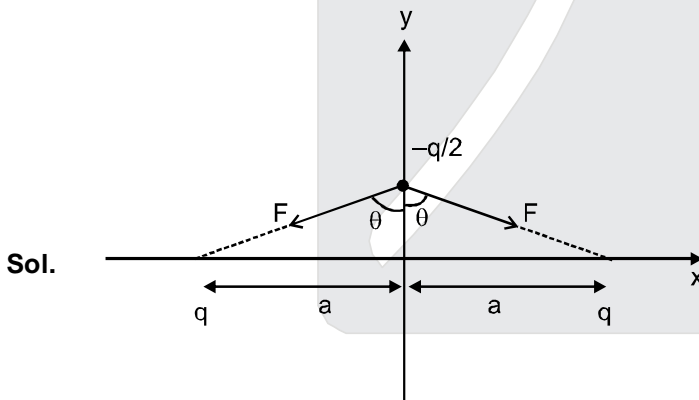

Sol.

$$\Rightarrow \begin{array}{c} \text{Fsin}\theta \leftarrow \text{Fsin}\theta \\ \downarrow \\ 2\text{Fcos}\theta \end{array} \quad \Rightarrow \quad \text{F}_{\text{net}} = 2\text{Fcos}\theta$$

$$\text{F}_{\text{net}} = \frac{2kq\left(\frac{q}{2}\right)}{\left(\sqrt{y^2 + a^2}\right)^2} \cdot \frac{y}{\sqrt{y^2 + a^2}}$$

$$\text{F}_{\text{net}} = \frac{2kq\left(\frac{q}{2}\right)y}{(y^2 + a^2)^{3/2}} \Rightarrow \frac{kq^2y}{a^3} \propto y$$

Ans. (1)

29. Two short bar magnets of length 1 cm each have magnetic moments 1.20 Am^2 and 1.00 Am^2 respectively. They are placed on a horizontal table parallel to each other with their N poles pointing towards the South. They have a common magnetic equator and are separated by a distance of 20.0 cm. The value of the resultant horizontal magnetic induction at the mid - point O of the line joining their centres is close to
(Horizontal component of earth's magnetic induction is $3.6 \times 10^{-5} \text{ Wb/m}^2$)

- (1) $3.6 \times 10^{-5} \text{ Wb/m}^2$ (2) $2.56 \times 10^{-4} \text{ Wb/m}^2$ (3) $3.50 \times 10^{-4} \text{ Wb/m}^2$ (4) $5.80 \times 10^{-4} \text{ Wb/m}^2$

Sol. $B_{\text{net}} = B_1 + B_2 + B_H$

$$B_{\text{net}} = \frac{\mu_0 (M_1 + M_2)}{4\pi r^3} + B_H$$

$$= \frac{10^{-7} (1.2 + 1)}{(0.1)^3} + 3.6 \times 10^{-5} = 2.56 \times 10^{-4} \text{ wb/m}^2$$

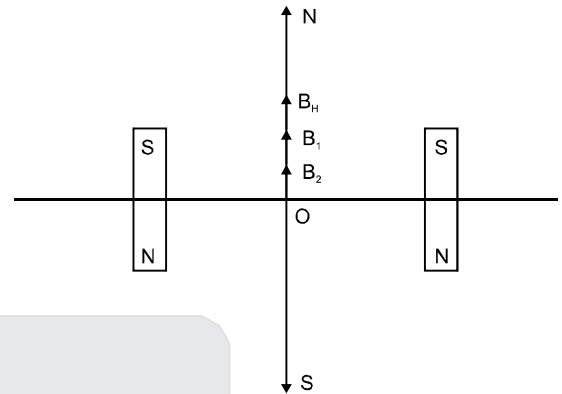

Ans. (2)

30. A charge Q is uniformly distributed over a long rod AB of length L as shown in the figure. The electric potential at the point O lying at distance L from the end A is :

- (1) $\frac{Q}{8\pi \epsilon_0 L}$ (2) $\frac{3Q}{4\pi \epsilon_0 L}$ (3) $\frac{Q}{4\pi \epsilon_0 L \ln 2}$ (4) $\frac{Q \ln 2}{4\pi \epsilon_0 L}$

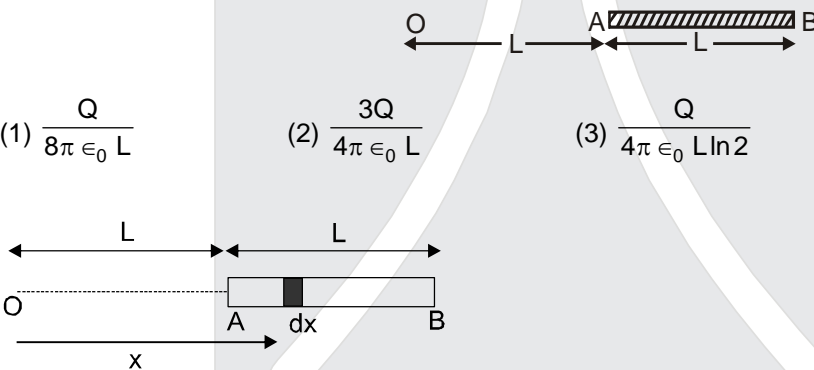

Sol.

$$V = \int_L^{2L} \frac{k dq}{x}$$

$$= \int_L^{2L} \frac{1}{4\pi \epsilon_0} \frac{\left(\frac{q}{L}\right) dx}{x}$$

$$= \frac{q}{4\pi \epsilon_0 L} \ln(2)$$

Ans. (4)

PART B – CHEMISTRY

31. Which of the following complex species is not expected to exhibit optical isomerism ?

- (1) $[\text{Co}(\text{en})_3]^{3+}$ (2) $[\text{Co}(\text{en})_2\text{Cl}_2]^+$
 (3) $[\text{Co}(\text{NH}_3)_3\text{Cl}_3]$ (4) $[\text{Co}(\text{en})(\text{NH}_3)_2\text{Cl}_2]^+$

Ans. (3)

Sol. $[\text{Co}(\text{NH}_3)_3\text{Cl}_3]$ show facial as well as meridional isomerism. But both contain plane of symmetry. So, the answer is (3).

32. Which one of the following molecules is expected to exhibit diamagnetic behaviour ?

- (1) C_2 (2) N_2 (3) O_2 (4) S_2

Ans. (1) and (2)

Sol. N_2 and C_2 both are diamagnetic

Ans is (1) and (2).

33. A solution of (–) – 1 – chloro–1–phenylethane in toluene racemises slowly in the presence of a small amount of SbCl_5 , due to the formation of :

- (1) carbanion (2) carbene
 (3) carbocation (4) free radical

Ans. (3)

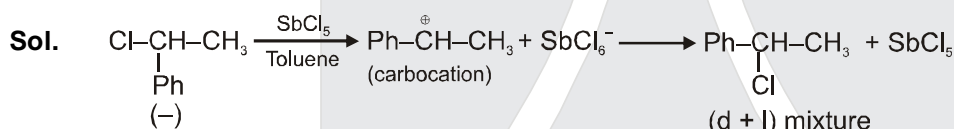

34. Given: $E_{\text{Cl}^{3+}/\text{Cl}}^0 = -0.74 \text{ V}$; $E_{\text{MnO}_4^-/\text{Mn}^{2+}}^0 = 1.51 \text{ V}$

$$E_{\text{Cr}_2\text{O}_7^{2-}/\text{Cr}^{3+}}^0 = 1.33 \text{ V} ; E_{\text{Cl}/\text{Cl}^-}^0 = 1.36 \text{ V}$$

Based on the data given above, strongest oxidising agent will be :

- (1) Cl (2) Cr^{3+} (3) Mn^{2+} (4) MnO_4^-

Ans. (4)

Sol. Higher the SRP, better is oxidising agent

Hence MnO_4^- is strongest oxidising agent.

35. A piston filled with 0.04 mol of an ideal gas expands reversibly from 50.0 mL to 375 mL at a constant temperature of 37.0°C. As it does so, it absorbs 208 J of heat. The values of q and w for the process will be:

($R = 8.314 \text{ J/mol K}$) ($\ln 7.5 = 2.01$)

- (1) $q = +208 \text{ J}$, $w = -208 \text{ J}$ (2) $q = -208 \text{ J}$, $w = -208 \text{ J}$
 (3) $q = -208 \text{ J}$, $w = +208 \text{ J}$ (4) $q = +208 \text{ J}$, $w = +208 \text{ J}$

Ans. (1)

Sol. The process is isothermal expansion Hence, $q = -w$ $\Delta u = 0$

$$q = +208 \text{ J}$$

$$w = -208 \text{ J (expansion work)}$$

36. The molarity of a solution obtained by mixing 750 mL of 0.5(M) HCl with 250 mL of 2(M)HCl will be :
 (1) 0.875 M (2) 1.00 M (3) 1.75 M (4) 0.975 M

Ans. (1)

Sol.
$$M_f = \frac{M_1V_1 + M_2V_2}{V_1 + V_2} = \frac{0.5 \times \frac{3}{4} + 2 \times \frac{1}{4}}{1} = 0.875 \text{ M.}$$

37. Arrange the following compounds in order of decreasing acidity :

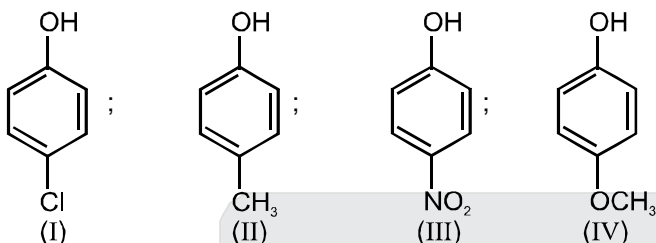

- Ans. (1) II > IV > I > III (2) I > II > III > IV
 (3) III > I > II > IV (4) IV > III > I > II

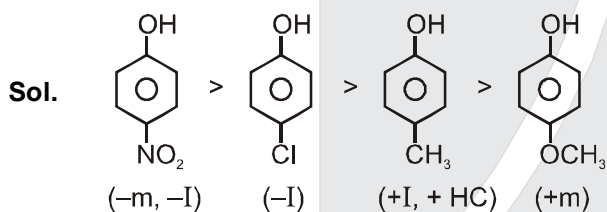

electron releasing group decreases and electron withdrawing group increases acidic strength.

38. For gaseous state, if most probable speed is denoted by C^* , average speed by \bar{C} and mean square speed by C , then for a large number of molecules the ratios of these speeds are :

- (1) $C^* : \bar{C} : C = 1.225 : 1.128 : 1$ (2) $C^* : \bar{C} : C = 1.128 : 1.225 : 1$
 (3) $C^* : \bar{C} : C = 1 : 1.128 : 1.225$ (4) $C^* : \bar{C} : C = 1 : 1.225 : 1.128$

Ans. (3)

Sol. $C^* = \text{most probable speed} = \sqrt{\frac{2RT}{M}}$

$\bar{C} = \text{average speed} = \sqrt{\frac{8RT}{\pi M}}$

$C = \text{Mean square speed corrected as rms} = \sqrt{\frac{3RT}{M}}$

$C^* < \bar{C} < C$

$C^* : \bar{C} : C = 1 : \sqrt{\frac{4}{\pi}} : \sqrt{\frac{3}{2}} = 1 : 1.128 : 1.225$

Note : As no option correspond to mean square speed, it is understood as misprint. It should be root means square speed

So, **Ans is (3)**

39. The rate of a reaction doubles when its temperature changes from 300 K to 310 K. Activation energy of such a reaction will be : ($R = 8.314 \text{ JK}^{-1} \text{ mol}^{-1}$ and $\log 2 = 0.301$)
- (1) 53.6 kJ mol^{-1} (2) 48.6 kJ mol^{-1}
 (3) 58.5 kJ mol^{-1} (4) 60.5 kJ mol^{-1}

Ans. (1)

Sol.
$$\log \frac{K_2}{K_1} = \frac{-E_a}{2.303R} \left(\frac{1}{T_2} - \frac{1}{T_1} \right)$$

$$\frac{K_2}{K_1} = 2 ; T_2 = 310 \text{ K} \quad T_1 = 300 \text{ K}$$

$$\Rightarrow \log 2 = \frac{-E_a}{2.303 \times 8.134} \left(\frac{1}{310} - \frac{1}{300} \right)$$

$$\Rightarrow E_a = 53598.6 \text{ J/mol} = 53.6 \text{ KJ/mol}$$

Ans is (1)

40. A compound with molecular mass 180 is acylated with CH_3COCl to get a compound with molecular mass 390. The number of amino groups present per molecule of the former compound is :
- (1) 2 (2) 5
 (3) 4 (4) 6

Ans. (2)

- Sol. By reaction with one mole of CH_3COCl with one $-\text{NH}_2$ group the molecular mass increases with 42 unit. Since the mass increases by $(390 - 180) = 210$ hence the number of $-\text{NH}_2$ groups is 5.

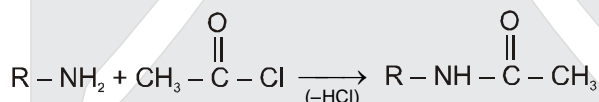

41. Which of the following arrangements does not represent the correct order of the property stated against it ?
- (1) $\text{V}^{2+} < \text{Cr}^{2+} < \text{Mn}^{2+} < \text{Fe}^{2+}$: paramagnetic behaviour
 (2) $\text{Ni}^{2+} < \text{Co}^{2+} < \text{Fe}^{2+} < \text{Mn}^{2+}$: ionic size
 (3) $\text{Co}^{3+} < \text{Fe}^{3+} < \text{Cr}^{3+} < \text{Sc}^{3+}$: stability in aqueous solution
 (4) $\text{Sc} < \text{Ti} < \text{Cr} < \text{Mn}$: number of oxidation states

Ans. (1)

- Sol. (1) $\text{V}^{2+} = 3$ unpaired electrons
 $\text{Cr}^{2+} = 4$ unpaired electrons
 $\text{Mn}^{2+} = 5$ unpaired electrons
 $\text{Fe}^{2+} = 4$ unpaired electrons
 Hence the order of paramagnetic behaviour should be
 $\text{V}^{2+} < \text{Cr}^{2+} < \text{Fe}^{2+} < \text{Mn}^{2+}$
- (2) ionic size decrease from left to right in same period
- (3) As per data from NCERT.
 $\text{Co}^{3+} / \text{Co}^{2+} = 1.97$; $\text{Fe}^{3+} / \text{Fe}^{2+} = 0.77$; $\text{Cr}^{3+} / \text{Cr}^{2+} = -0.41$
 Sc^{3+} is highly stable (It does not show +2)
- (4) The oxidation states increases as we go from group 3 to group 7 in same period.

Ans is (1)

42. The order of stability of the following carbocations :

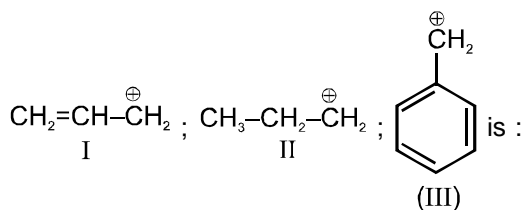

(1) III > II > I

(2) II > III > I

(3) I > II > III

(4) III > I > II

Ans. (4)

Sol. The order of stability of carbocation will be

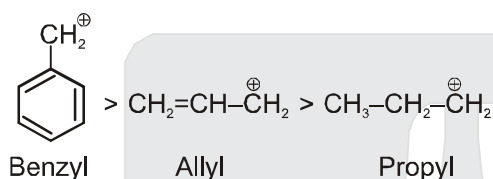

43. Consider the following reaction :

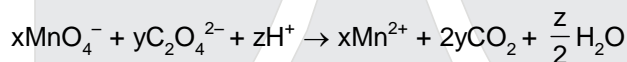

The values of x, y and z in the reaction are, respectively :

(1) 5, 2 and 16

(2) 2, 5 and 8

(3) 2, 5 and 16

(4) 5, 2 and 8

Ans. (3)

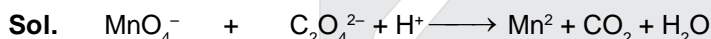

$$vf = 1(7 - 2) \quad vf = 2(3 - 2)$$

$$= 5$$

$$= 2$$

∴ Balanced Equation :

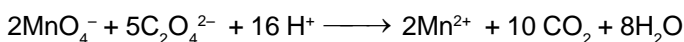

So, x = 2, y = 5 & z = 16.

44. Which of the following is the wrong statement ?

(1) ONCl and ONO^- are not isoelectronic.

(2) O_3 molecule is bent

(3) Ozone is violet-black in solid state

(4) Ozone is diamagnetic gas.

Ans. (All statement are correct there is no answer).

Sol. (1) $\text{ONCl} = 8 + 7 + 17 = 32e^-$

$$\text{ONO}^- = 8 + 7 + 8 + 1 = 24e^- \text{ (correct)}$$

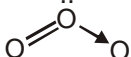
(2)  Central atom O is sp^2 hybridised with 1 lone pair, so bent shape (correct)

(3) Ozone is violet-black in solid state. (Ref. NCERT & shriver atkins)

(4) O_3 has no unpaired electrons, so diamagnetic (correct)

45. A gaseous hydrocarbon gives upon combustion 0.72 g of water and 3.08 g. of CO₂. The empirical formula of the hydrocarbon is :

- (1) C₂H₄ (2) C₃H₄
 (3) C₆H₅ (4) C₇H₈

Ans. (4)

Sol. 18g H₂O contains 2g H
 ∴ 0.72 g H₂O contains 0.08 gH.
 44 g CO₂ contains 12g C
 ∴ 3.08 g CO₂ contains 0.84 g C

$$\therefore C : H = \frac{0.84}{12} : \frac{0.08}{1} = 0.07 : 0.08$$

$$= 7 : 8$$

∴ Empirical formula = C₇H₈

46. In which of the following pairs of molecules/ions, both the species are not likely to exist ?

- (1) H₂⁺, He₂²⁻ (2) H₂⁻, He₂²⁻
 (3) H₂²⁺, He₂ (4) H₂⁻, He₂²⁺

Ans. (3)

Sol. H₂²⁺ : Bond order = 0

$$\text{He}_2 : \text{Bond order} = \frac{2-2}{2} = 0$$

So, both H₂²⁺ & He₂ do not exist.

47. Which of the following exists as covalent crystals in the solid state ?

- (1) Iodine (2) Silicon
 (3) Sulphur (4) Phosphorus

Ans. (2)

Sol. Silicon exists as covalent crystal in solid state. (Network like structure, like diamond).

48. Synthesis of each molecule of glucose in photosynthesis involves :

- (1) 18 molecules of ATP (2) 10 molecules of ATP
 (3) 8 molecules of ATP (4) 6 molecules of ATP

Ans. (1) Fact

Sol. 6CO₂ + 12NADPH + 18 ATP → C₆H₁₂O₆ + 12NADP + 18 ADP

49. The coagulating power of electrolytes having ions Na⁺, Al³⁺ and Ba²⁺ for arsenic sulphide sol increases in the order :

- (1) Al³⁺ < Ba²⁺ < Na⁺ (2) Na⁺ < Ba²⁺ < Al³⁺
 (3) Ba²⁺ < Na⁺ < Al³⁺ (4) Al³⁺ < Na⁺ < Ba²⁺

Ans. (2)

Sol. According to Hardy Schulze rule, greater the charge on cation, greater is its coagulating power for negatively charged solution. So, order of coagulating power : Na⁺ < Ba²⁺ < Al³⁺.

53. Four successive members of the first row transition elements are listed below with atomic numbers. Which one of them is expected to have the highest $E_{M^{3+}/M^{2+}}^0$ value ?

- (1) Cr(Z = 24) (2) Mn(Z = 25)
 (3) Fe(Z = 26) (4) Co(Z = 27)

Ans. (4)

Sol. $E_{Cr^{3+}/Cr^{2+}}^0 = -0.41$ V ; $E_{Mn^{3+}/Mn^{2+}}^0 = +1.57$ V ; $E_{Fe^{3+}/Fe^{2+}}^0 = +0.77$ V ; $E_{Co^{3+}/Co^{2+}}^0 = +1.97$ V
 SRP value normally increases from left to right in the period of d-block elements. Some SRP value are exceptionally higher due to stability of product ion. For e.g. $E_{Mn^{3+}/Mn^{2+}}^0 = +1.57$ V ; $E_{Co^{3+}/Co^{2+}}^0 = +1.97$ V.

54. How many litres of water must be added to 1 litre an aqueous solution of HCl with a pH of 1 to create an aqueous solution with pH of 2 ?

- (1) 0.1 L (2) 0.9 L
 (3) 2.0 L (4) 9.0 L

Ans. (4)

Sol. pH = 1 $[H^+] = 10^{-1} = 0.1$ M
 pH = 2 $[H^+] = 10^{-2} = 0.01$ M
 for dilution of HCl $M_1V_1 = M_2V_2$
 $0.1 \times 1 = 0.01 \times V_2$
 $V_2 = 10$ lt
 Volume of water added = $10 - 1 = 9$ litre.

55. The first ionisation potential of Na is 5.1 eV. The value of electron gain enthalpy of Na^+ will be :

- (1) -2.55 eV (2) -5.1 eV
 (3) -10.2 eV (4) +2.55 eV

Ans. (2)

Sol. $Na \longrightarrow Na^+ + e^-$ 1st I.E.
 $Na^+ + e^- \longrightarrow Na$ Electron gain enthalpy of Na^+
 Because reaction is reverse so then.
 $\Delta H_{eg} = -5.1$ eV.

56. An organic compound A upon reacting with NH_3 gives B. On heating B gives C. C in presence of KOH reacts with Br_2 to given $CH_3CH_2NH_2$. A is :

- (1) CH_3COOH (2) $CH_3CH_2CH_2COOH$
 (3) $CH_3-\underset{\substack{| \\ CH_3}}{CH}-COOH$ (4) CH_3CH_2COOH

Ans. (4)

Sol. $CH_3CH_2-\overset{O}{\parallel}C-OH$ (A) $\xrightarrow{NH_3}$ $CH_3CH_2-\overset{O}{\parallel}C-O^{\ominus}NH_4^{\oplus}$ (B) $\xrightarrow{\Delta}$ $CH_3-\overset{O}{\parallel}C-NH_2$ (C) $\xrightarrow[\text{Hofmann bromamide reaction}]{Br_2, KOH}$ $CH_3-CH_2-NH_2$

57. Stability of the species Li_2 , Li_2^- and Li_2^+ increases in the order of :

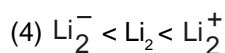
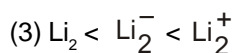
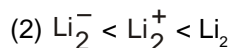

Ans. (2)

Sol. Li_2 $\sigma 1s^2 \sigma^* 1s^2 \sigma 2s^2$ Bond order = 1

Li_2^+ $\sigma 1s^2 \sigma^* 1s^2 \sigma 2s^1$ Bond order = 0.5

Li_2^- $\sigma 1s^2 \sigma^* 1s^2 \sigma 2s^2 \sigma^* 2s^1$ Bond order = 0.5

Stability order $\text{Li}_2 > \text{Li}_2^+ > \text{Li}_2^-$

58. An unknown alcohol is treated with the "Lucas reagent" to determine whether the alcohol is primary, secondary or tertiary. Which alcohol reacts fastest and by what mechanism :

(1) secondary alcohol by $\text{S}_\text{N}1$

(2) tertiary alcohol by $\text{S}_\text{N}1$

(3) secondary alcohol by $\text{S}_\text{N}2$

(4) tertiary alcohol by $\text{S}_\text{N}2$

Ans. (2)

Sol. The reaction of alcohol with Lucas reagent is mostly an $\text{S}_\text{N}1$ reaction and the rate of reaction is directly proportional to the carbocation stability formed in the reaction, since 3°R-OH forms 3° carbocation hence it will react fastest.

59. The gas leaked from a storage tank of the Union Carbide plant in Bhopal gas tragedy was :

(1) Methylisocyanate

(2) Methylamine

(3) Ammonia

(4) Phosgene

Ans. (1)

Sol. Methyl isocyanate $\text{CH}_3 - \text{N} = \text{C} = \text{O}$ (MIC gas) (Fact)

60. Experimentally it was found that a metal oxide has formula $\text{M}_{0.98}\text{O}$. Metal M, present as M^{2+} and M^{3+} in its oxide. Fraction of the metal which exists as M^{3+} would be :

(1) 7.01%

(2) 4.08%

(3) 6.05%

(4) 5.08%

Ans. (2)

Sol. $\text{M}_{0.98}\text{O}$

consider one mole of the oxide.

Moles of M = 0.98, Moles of O^{2-} = 1

Let moles of M^{3+} = x

\Rightarrow Moles of M^{2+} = $0.98 - x$

\Rightarrow Doing charge balance

$$(0.98 - x) \times 2 + 3x - 2 = 0$$

$\Rightarrow 1.96 - 2x + 3x - 2 = 0$

$\Rightarrow x = 0.04$

\Rightarrow % of M^{3+} = $\frac{0.04}{0.98} \times 100 = 4.08\%$

PART C – MATHEMATICS

61. Distance between two parallel planes $2x + y + 2z = 8$ and $4x + 2y + 4z + 5 = 0$ is

- (1) $\frac{3}{2}$ (2) $\frac{5}{2}$ (3) $\frac{7}{2}$ (4) $\frac{9}{2}$

Sol. (3)

$$2x + y + 2z - 8 = 0 \quad \dots(P_1)$$

$$2x + y + 2z + \frac{5}{2} = 0 \quad \dots(P_2)$$

$$\text{Distance between } P_1 \text{ and } P_2 = \frac{\left| -8 - \frac{5}{2} \right|}{\sqrt{2^2 + 1^2 + 2^2}} = \frac{7}{2}$$

62. At present, a firm is manufacturing 2000 items. It is estimated that the rate of change of production P w.r.t.

additional number of workers x is given by $\frac{dP}{dx} = 100 - 12\sqrt{x}$. If the firm employs 25 more workers, then the

new level of production of items is

- (1) 2500 (2) 3000 (3) 3500 (4) 4500

Sol. (3)

$$dP = (100 - 12\sqrt{x}) dx$$

By integrating

$$\int dP = \int (100 - 12\sqrt{x}) dx$$

$$P = 100x - 8x^{3/2} + C$$

$$\text{When } x = 0 \text{ then } P = 2000$$

$$\Rightarrow C = 2000$$

Now when $x = 25$ then P is

$$P = 100 \times 25 - 8 \times (25)^{3/2} + 2000$$

$$= 2500 - 8 \times 125 + 2000$$

$$= 4500 - 1000$$

$$\Rightarrow P = 3500$$

63. Let A and B two sets containing 2 elements and 4 elements respectively. The number of subsets of $A \times B$ having 3 or more elements is

- (1) 256 (2) 220 (3) 219 (4) 211

Sol. (3)

$$n(A) = 2$$

$$n(B) = 4$$

$$n(A \times B) = 8$$

$${}^8C_3 + {}^8C_4 + \dots + {}^8C_8 = 2^8 - {}^8C_0 - {}^8C_1 - {}^8C_2$$

$$= 256 - 1 - 8 - 28$$

$$= 219$$

64. If the lines $\frac{x-2}{1} = \frac{y-3}{1} = \frac{z-4}{-k}$ and $\frac{x-1}{k} = \frac{y-4}{2} = \frac{z-5}{1}$ are coplanar, then k can have

- (1) any value (2) exactly one value (3) exactly two values (4) exactly three values

Sol. (3)

$$[a - c, b, d] = 0$$

$$\begin{vmatrix} 2-1 & 3-4 & 4-5 \\ 1 & 1 & -k \\ k & 2 & 1 \end{vmatrix} = 0$$

$$\begin{vmatrix} 1 & -1 & -1 \\ 1 & 1 & -k \\ k & 2 & 1 \end{vmatrix} = 0$$

$$\Rightarrow 1(1 + 2k) + (1 + k^2) - (2 - k) = 0$$

$$\Rightarrow k^2 + 2k + k = 0$$

$$\Rightarrow k^2 + 3k = 0$$

$$\Rightarrow k = 0, -3$$

Note : If 0 appears in the denominator, then the correct way of representing the equation of straight line is

$$\frac{x-2}{1} = \frac{y-3}{1}; z = 4$$

65. If the vectors $\vec{AB} = 3\hat{i} + 4\hat{k}$ and $\vec{AC} = 5\hat{i} - 2\hat{j} + 4\hat{k}$ are the sides of a triangle ABC, then the length of the median through A is

(1) $\sqrt{18}$

(2) $\sqrt{72}$

(3) $\sqrt{33}$

(4) $\sqrt{45}$

Sol. (3)

$$\vec{AB} + \vec{BC} + \vec{CA} = 0$$

$$\Rightarrow \vec{BC} = \vec{AC} - \vec{AB}$$

$$\Rightarrow \vec{BM} = \frac{\vec{AC} - \vec{AB}}{2}$$

$$\Rightarrow \vec{AB} + \vec{BM} + \vec{MA} = 0$$

$$\Rightarrow \vec{AB} + \frac{\vec{AC} - \vec{AB}}{2} = \vec{AM}$$

$$\Rightarrow \vec{AM} = \frac{\vec{AB} + \vec{AC}}{2} = 4\hat{i} - \hat{j} + 4\hat{k}$$

$$\Rightarrow |\vec{AM}| = \sqrt{33}$$

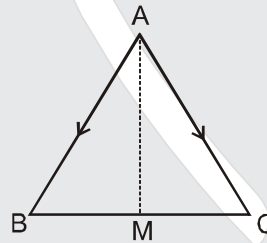

66. The real number k for which the equation, $2x^3 + 3x + k = 0$ has two distinct real roots in $[0, 1]$

(1) lies between 1 and 2

(2) lies between 2 and 3

(3) lies between -1 and 0

(4) does not exist.

Sol. (4)

$$f(x) = 2x^3 + 3x + k$$

$$f'(x) = 6x^2 + 3 > 0 \quad \forall x \in \mathbb{R}$$

$\Rightarrow f(x)$ is strictly increasing function

$\Rightarrow f(x) = 0$ has only one real root, so two roots are not possible

67. The sum of first 20 terms of the sequence 0.7, 0.77, 0.777,....., is

(1) $\frac{7}{81}(179 - 10^{-20})$

(2) $\frac{7}{9}(99 - 10^{-20})$

(3) $\frac{7}{81}(179 + 10^{-20})$

(4) $\frac{7}{9}(99 + 10^{-20})$

Sol. (3)

$$\begin{aligned} & \frac{7}{10} + \frac{77}{100} + \frac{777}{10^3} + \dots + \text{up to 20 terms} \\ &= 7 \left[\frac{1}{10} + \frac{11}{100} + \frac{111}{10^3} + \dots + \text{up to 20 terms} \right] \\ &= \frac{7}{9} \left[\frac{9}{10} + \frac{99}{100} + \frac{999}{1000} + \dots + \text{up to 20 terms} \right] \\ &= \frac{7}{9} \left[\left(1 - \frac{1}{10}\right) + \left(1 - \frac{1}{10^2}\right) + \left(1 - \frac{1}{10^3}\right) + \dots + \text{up to 20 terms} \right] \\ &= \frac{7}{9} \left[20 - \frac{1 - \left(\frac{1}{10}\right)^{20}}{1 - \frac{1}{10}} \right] = \frac{7}{9} \left[20 - \frac{1 - \left(\frac{1}{10}\right)^{20}}{\frac{9}{10}} \right] \\ &= \frac{7}{9} \left[\frac{179}{9} + \frac{1}{9} \left(\frac{1}{10}\right)^{20} \right] = \frac{7}{81} [179 + (10)^{-20}] \end{aligned}$$

68. A ray of light along $x + \sqrt{3}y = \sqrt{3}$ gets reflected upon reaching x-axis, the equation of the reflected ray is

- (1) $y = x + \sqrt{3}$ (2) $\sqrt{3}y = x - \sqrt{3}$ (3) $y = \sqrt{3}x - \sqrt{3}$ (4) $\sqrt{3}y = x - 1$

Sol. (2)

Take any point B(0, 1) on given line
Equation of AB'

$$y - 0 = \frac{-1 - 0}{0 - \sqrt{3}} (x - \sqrt{3})$$

$$-\sqrt{3}y = -x + \sqrt{3}$$

$$x - \sqrt{3}y = \sqrt{3} \Rightarrow \sqrt{3}y = x - \sqrt{3}$$

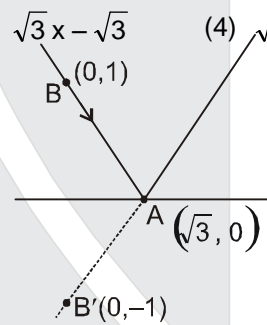

69. The number of values of k, for which the system of equations :

$$\begin{aligned} (k + 1)x + 8y &= 4k \\ kx + (k + 3)y &= 3k - 1 \end{aligned}$$

has no solution, is

- (1) infinite (2) 1 (3) 2 (4) 3

Sol. (2)

$$\frac{k+1}{k} = \frac{8}{k+3} \neq \frac{4k}{3k-1}$$

$$k^2 + 4k + 3 = 8k$$

$$k^2 - 4k + 3 = 0$$

$$k = 1, 3$$

$$\text{If } k = 1$$

$$\text{then } \frac{8}{1+3} \neq \frac{4.1}{2} \quad \text{False}$$

And if $k = 3$

$$\text{then } \frac{8}{6} \neq \frac{4.3}{9-1} \quad \text{True}$$

therefore $k = 3$

Hence only one value of k.

70. If the equations $x^2 + 2x + 3 = 0$ and $ax^2 + bx + c = 0$, $a, b, c \in \mathbb{R}$, have a common root, then $a : b : c$ is
 (1) $1 : 2 : 3$ (2) $3 : 2 : 1$ (3) $1 : 3 : 2$ (4) $3 : 1 : 2$

Sol. (1)

$$x^2 + 2x + 3 = 0 \quad \dots(i)$$

$$ax^2 + bx + c = 0 \quad \dots(ii)$$

Since equation (i) has imaginary roots

So equation (ii) will also have both roots same as (i). Thus

$$\frac{a}{1} = \frac{b}{2} = \frac{c}{3} \quad \Rightarrow \quad a = \lambda, b = 2\lambda, c = 3\lambda$$

Hence $1 : 2 : 3$

71. The circle passing through $(1, -2)$ and touching the axis of x at $(3, 0)$ also passes through the point
 (1) $(-5, 2)$ (2) $(2, -5)$ (3) $(5, -2)$ (4) $(-2, 5)$

Sol. (3)

Let the equation of circle be

$$(x - 3)^2 + (y - 0)^2 + \lambda y = 0$$

As it passes through $(1, -2)$

$$\therefore (1 - 3)^2 + (-2)^2 + \lambda(-2) = 0$$

$$\Rightarrow \lambda = 4$$

\therefore equation of circle is

$$(x - 3)^2 + y^2 - 8 = 0$$

so $(5, -2)$ satisfies equation of circle

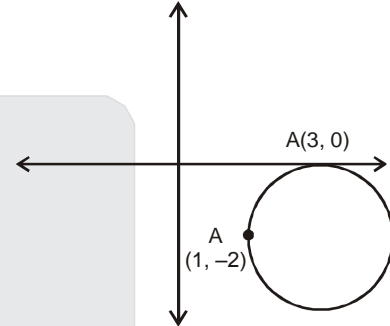

72. If x, y, z are in A.P. and $\tan^{-1}x, \tan^{-1}y$ and $\tan^{-1}z$ are also in A.P., then

- (1) $x = y = z$ (2) $2x = 3y = 6z$ (3) $6x = 3y = 2z$ (4) $6x = 4y = 3z$

Sol. (1)

$$2y = x + z$$

$$2 \tan^{-1} y = \tan^{-1} x + \tan^{-1} (z)$$

$$\tan^{-1} \left(\frac{2y}{1-y^2} \right) = \tan^{-1} \left(\frac{x+z}{1-xz} \right)$$

$$\frac{x+z}{1-y^2} = \frac{x+z}{1-xz}$$

$$\Rightarrow y^2 = xz \quad \text{or} \quad x + z = 0 \quad \Rightarrow \quad x = y = z$$

Disclaimer : It should be given that $xz \neq 1$ as other wise for instant $x = \frac{1}{\sqrt{3}}, y = 1, z = \sqrt{3}$ are also potential answers which are not there in other choice.

73. Consider

Statement-I : $(p \wedge \sim q) \wedge (\sim p \wedge q)$ is a fallacy.

Statement-II : $(p \rightarrow q) \leftrightarrow (\sim q \rightarrow \sim p)$ is a tautology.

- (1) Statement-I is true; Statement-II is true; Statement-II is a correct explanation for Statement-I.
 (2) Statement-I is true; Statement-II is true; Statement-II is **not** a correct explanation for Statement-I.
 (3) Statement-I is true; Statement-II is false.
 (4) Statement-I is false; Statement-II is true.

Sol. (2)

$$\text{Statement-II : } (p \rightarrow q) \leftrightarrow (\sim q \rightarrow \sim p)$$

$$\equiv (p \rightarrow q) \leftrightarrow (p \rightarrow q)$$

which is always true

so statement -II is true

$$\text{Statement-I : } (p \wedge \sim q) \wedge (\sim p \wedge q)$$

$$= p \wedge \sim q \wedge \sim p \wedge q$$

$$\begin{aligned}
 &= p \wedge \sim p \wedge \sim q \wedge q \\
 &= f \wedge f \\
 &= f
 \end{aligned}$$

so statement -I is true

Alternate

Statement-II : $(p \rightarrow q) \leftrightarrow (\sim q \rightarrow \sim p)$

$\sim q \rightarrow \sim p$ is contrapositive

of $p \rightarrow q$ hence $(p \rightarrow q) \leftrightarrow (p \rightarrow q)$

will be a tautology

statement -II $(p \wedge \sim q) \wedge (\sim p \wedge q)$

p	q	$P \wedge \sim q$	$\sim p \wedge q$	$(p \wedge \sim q) \wedge (\sim p \wedge q)$
T	T	F	F	F
T	F	T	F	F
F	T	F	T	F
F	F	F	F	F

\therefore It is a fallacy

74. If $\int f(x)dx = \psi(x)$, then $\int x^5 f(x^3)dx$ is equal to

(1) $\frac{1}{3} [x^3 \psi(x^3) - \int x^2 \psi(x^3) dx] + C$

(2) $\frac{1}{3} x^3 \psi(x^3) - 3 \int x^3 \psi(x^3) dx + C$

(3) $\frac{1}{3} x^3 \psi(x^3) - \int x^2 \psi(x^3) dx + C$

(4) $\frac{1}{3} [x^3 \psi(x^3) - \int x^3 \psi(x^3) dx] + C$

Sol. (3)

$$\int f(x)dx = \psi(x)$$

$$I = \int x^5 f(x^3) dx$$

put $x^3 = t \Rightarrow x^2 dx = \frac{dt}{3}$

$$= \frac{1}{3} \int t f(t) dt$$

$$= \frac{1}{3} [t \psi(t) - \int \psi(t) dt]$$

$$= \frac{1}{3} [x^3 \psi(x^3) - 3 \int x^2 \psi(x^3) dx] + c$$

$$= \frac{1}{3} x^3 \psi(x^3) - \int x^2 \psi(x^3) dx + c$$

75. $\lim_{x \rightarrow 0} \frac{(1 - \cos 2x)(3 + \cos x)}{x \tan 4x}$ is equal to

(1) $-\frac{1}{4}$

(2) $\frac{1}{2}$

(3) 1

(4) 2

Sol. (4)

$$I = \lim_{x \rightarrow 0} \frac{(1 - \cos 2x)}{x^2} \cdot \frac{(3 + \cos x)}{1} \cdot \frac{x}{\tan 4x}$$

$$= \lim_{x \rightarrow 0} \frac{2 \sin^2 x}{x^2} \cdot \frac{3 + \cos x}{1} \cdot \frac{x}{\tan 4x}$$

$$= 2.4 \cdot \frac{1}{4} = 2$$

76. Statement-I : The value of the integral $\int_{\pi/6}^{\pi/3} \frac{dx}{1 + \sqrt{\tan x}}$ is equal to $\pi/6$.

Statement-II : $\int_a^b f(x) dx = \int_a^b f(a+b-x) dx$.

- (1) Statement-I is true; Statement-II is true; Statement-II is a **correct** explanation for Statement-I.
 (2) Statement-I is true; Statement-II is true; Statement-II is **not** a correct explanation for Statement-I.
 (3) Statement-I is true; Statement-II is false.
 (4) Statement-I is false; Statement-II is true.

Sol. (4)

$$I = \int_{\pi/6}^{\pi/3} \frac{dx}{1 + \sqrt{\tan x}}$$

$$= \int_{\pi/6}^{\pi/3} \frac{dx}{1 + \sqrt{\tan\left(\frac{\pi}{2} - x\right)}}$$

$$= \int_{\pi/6}^{\pi/3} \frac{\sqrt{\tan x} dx}{1 + \sqrt{\tan x}}$$

$$= \int_{\pi/6}^{\pi/3} \frac{\sqrt{\tan x} dx}{1 + \sqrt{\tan x}}$$

$$\Rightarrow 2I = \int_{\pi/6}^{\pi/3} dx$$

$$\Rightarrow I = \frac{1}{2} \left[\frac{\pi}{3} - \frac{\pi}{6} \right] = \frac{\pi}{12}, \quad \text{statement -1 is false}$$

$$\int_a^b f(x) dx = \int_a^b f(a+b-x) dx \quad \text{it is property}$$

77. The equation of the circle passing through the foci of the ellipse $\frac{x^2}{16} + \frac{y^2}{9} = 1$, and having centre at (0, 3) is

(1) $x^2 + y^2 - 6y - 7 = 0$

(2) $x^2 + y^2 - 6y + 7 = 0$

(3) $x^2 + y^2 - 6y - 5 = 0$

(4) $x^2 + y^2 - 6y + 5 = 0$

Sol. (1)

$$a = 4, b = 3, e = \sqrt{1 - \frac{9}{16}} \Rightarrow \frac{\sqrt{7}}{4}$$

$$\text{Foci is } (\pm ae, 0) \Rightarrow (\pm \sqrt{7}, 0)$$

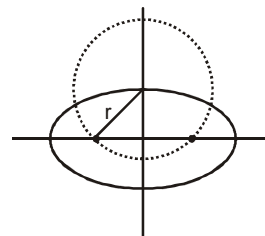

$$r = \sqrt{(ae)^2 + b^2}$$

$$\sqrt{7+9}$$

$$= 4$$

Now equation of circle is $(x - 0)^2 + (y - 3)^2 = 16$

$$x^2 + y^2 - 6y - 7 = 0$$

78. A multiple choice examination has 5 questions. Each question has three alternative answers of which exactly one is correct. The probability that a student will get 4 or more correct answers just by guessing is :

(1) $\frac{17}{3^5}$

(2) $\frac{13}{3^5}$

(3) $\frac{11}{3^5}$

(4) $\frac{10}{3^5}$

Sol. (3)

$$p = \frac{1}{3}, q = \frac{2}{3}$$

$${}^5C_4 \left(\frac{1}{3}\right)^4 \cdot \frac{2}{3} + {}^5C_5 \left(\frac{1}{3}\right)^5$$

$$= 5 \cdot \frac{2}{3^5} + \frac{1}{3^5} = \frac{11}{3^5}$$

79. The x-coordinate of the incentre of the triangle that has the coordinates of mid points of its sides as (0, 1), (1, 1) and (1, 0) is :

(1) $2 + \sqrt{2}$

(2) $2 - \sqrt{2}$

(3) $1 + \sqrt{2}$

(4) $1 - \sqrt{2}$

Sol. (2)

$$x\text{-coordinate of incentre} = \frac{2 \times 0 + 2\sqrt{2} \cdot 0 + 2 \cdot 2}{2 + 2 + 2\sqrt{2}}$$

$$= \frac{2}{2 + \sqrt{2}}$$

$$= 2 - \sqrt{2}$$

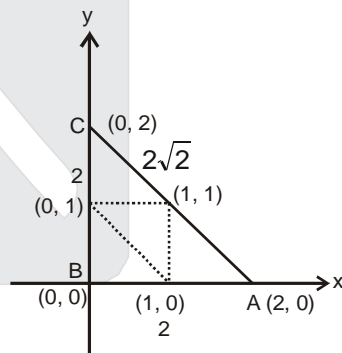

80. The term independent of x in expansion of $\left(\frac{x+1}{x^{2/3} - x^{1/3} + 1} - \frac{x-1}{x - x^{1/2}}\right)^{10}$ is :

(1) 4

(2) 120

(3) 210

(4) 310

Sol. (3)

$$\left(x^{1/3} + 1 - \left(\frac{\sqrt{x} + 1}{\sqrt{x}}\right)\right)^{10}$$

$$(x^{1/3} - x^{-1/2})^{10}$$

$$T_{r+1} = {}^{10}C_r (x^{1/3})^{10-r} (-x^{-1/2})^r$$

$$\frac{10-r}{3} - \frac{r}{2} = 0 \Rightarrow 20 - 2r - 3r = 0$$

$$\Rightarrow r = 4$$

$$T_5 = {}^{10}C_4 = \frac{10 \times 9 \times 8 \times 7}{4 \times 3 \times 2 \times 1} = 210$$

81. The area (in square units) bounded by the curves $y = \sqrt{x}$, $2y - x + 3 = 0$, x-axis, and lying in the first quadrant is :

- (1) 9 (2) 36 (3) 18 (4) $\frac{27}{4}$

Sol. (1)

$$y = \sqrt{x} \quad \dots\dots\dots(1)$$

$$\text{and } 2y - x + 3 = 0 \quad \dots\dots\dots(2)$$

On solving both $y = -1, 3$

$$\text{Required area} = \int_0^3 \{(2y+3) - y^2\} dy$$

$$= y^2 + 3y - \frac{y^3}{3} \Big|_0^3$$

$$= 9 + 9 - 9$$

$$= 9.$$

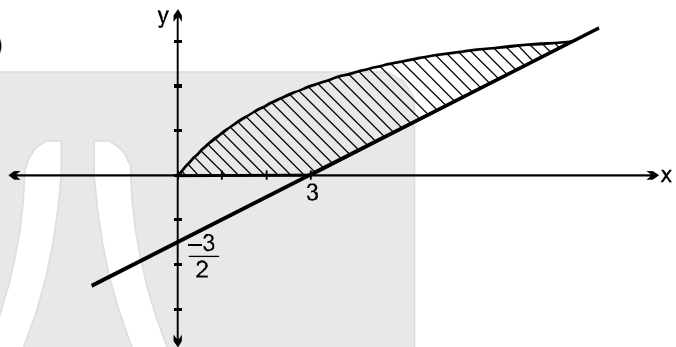

82. Let T_n be the number of all possible triangles formed by joining vertices of an n-sided regular polygon. If $T_{n+1} - T_n = 10$, then the value of n is :

- (1) 7 (2) 5 (3) 10 (4) 8

Sol. (2)

$$T_n = {}^nC_3$$

$$T_{n+1} = {}^{n+1}C_3$$

$$T_{n+1} - T_n = {}^{n+1}C_3 - {}^nC_3$$

$$\Rightarrow {}^nC_2 = 10$$

$$\Rightarrow n = 5.$$

83. If z is a complex number of unit modulus and argument θ , then $\arg \left(\frac{1+z}{1+\bar{z}} \right)$ equals :

- (1) $-\theta$ (2) $\frac{\pi}{2} - \theta$ (3) θ (4) $\pi - \theta$

Sol. (3)

$$|z| = 1, \arg z = \theta \quad z = e^{i\theta}$$

$$\bar{z} = \frac{1}{z}$$

$$\arg \left(\frac{1+z}{1+\frac{1}{z}} \right) = \arg(z) = \theta.$$

84. ABCD is a trapezium such that AB and CD are parallel and $BC \perp CD$. If $\angle ADB = \theta$, $BC = p$ and $CD = q$, then AB is equal to :

(1) $\frac{(p^2 + q^2) \sin \theta}{p \cos \theta + q \sin \theta}$ (2) $\frac{p^2 + q^2 \cos \theta}{p \cos \theta + q \sin \theta}$ (3) $\frac{p^2 + q^2}{p^2 \cos \theta + q^2 \sin \theta}$ (4) $\frac{(p^2 + q^2) \sin \theta}{(p \cos \theta + q \sin \theta)^2}$

Sol. (1)

Let $AB = x$

$$\tan(\pi - \theta - \alpha) = \frac{p}{x - q} \Rightarrow \tan(\theta + \alpha) = \frac{p}{q - x}$$

$$\Rightarrow q - x = p \cot(\theta + \alpha)$$

$$\Rightarrow x = q - p \cot(\theta + \alpha)$$

$$= q - p \left(\frac{\cot \theta \cot \alpha - 1}{\cot \alpha + \cot \theta} \right)$$

$$= q - p \left(\frac{\frac{q}{p} \cot \theta - 1}{\frac{q}{p} + \cot \theta} \right) = q - p \left(\frac{q \cot \theta - p}{q + p \cot \theta} \right) = q - p \left(\frac{q \cos \theta - p \sin \theta}{q \sin \theta + p \cos \theta} \right)$$

$$\Rightarrow x = \frac{q^2 \sin \theta + pq \cos \theta - pq \cos \theta + p^2 \sin \theta}{p \cos \theta + q \sin \theta} \Rightarrow AB = \frac{(p^2 + q^2) \sin \theta}{p \cos \theta + q \sin \theta}$$

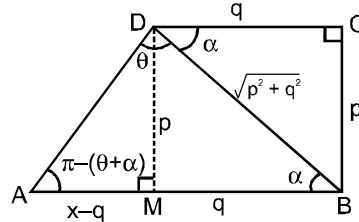

Alternative

From Sine Rule

$$\frac{AB}{\sin \theta} = \frac{\sqrt{p^2 + q^2}}{\sin(\pi - (\theta + \alpha))}$$

$$AB = \frac{\sqrt{p^2 + q^2} \sin \theta}{\sin \theta \cos \alpha + \cos \theta \sin \alpha}$$

$$= \frac{(p^2 + q^2) \sin \theta}{q \sin \theta + p \cos \theta}$$

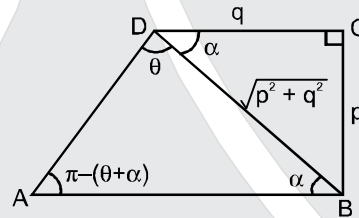

$$\left(\because \cos \alpha = \frac{q}{\sqrt{p^2 + q^2}} \right)$$

$$= \frac{(p^2 + q^2) \sin \theta}{p \cos \theta + q \sin \theta}$$

85. If $P = \begin{bmatrix} 1 & \alpha & 3 \\ 1 & 3 & 3 \\ 2 & 4 & 4 \end{bmatrix}$ is the adjoint of a 3×3 matrix A and $|A| = 4$, then α is equal to :

(1) 4

(2) 11

(3) 5

(4) 0

Sol. (2)

$$|P| = 1(12 - 12) - \alpha(4 - 6) + 3(4 - 6)$$

$$= 2\alpha - 6$$

$$|P| = |A|^2 = 16$$

$$2\alpha - 6 = 16$$

$$\alpha = 11.$$

86. The intercepts on x-axis made by tangents to the curve, $y = \int_0^x |t| dt$, $x \in \mathbb{R}$, which are parallel to the line $y = 2x$, are equal to :

(1) ± 1

(2) ± 2

(3) ± 3

(4) ± 4

Sol. (1)

$$\frac{dy}{dx} = |x| = 2$$

$$x = \pm 2$$

points $y = \int_0^{\pm 2} |t| dt = \pm 2$

\therefore equation of tangent is
 $y - 2 = 2(x - 2)$ or $y + 2 = 2(x + 2) \Rightarrow x$ - intercept = ± 1 .

87. Given : A circle, $2x^2 + 2y^2 = 5$ and a parabola, $y^2 = 4\sqrt{5}x$.

Statement-I : An equation of a common tangent to these curves is $y = x + \sqrt{5}$.

Statement-II : If the line, $y = mx + \frac{\sqrt{5}}{m}$ ($m \neq 0$) is their common tangent, then m satisfies $m^4 - 3m^2 + 2 = 0$.

- (1) Statement-I is true; Statement-II is true; Statement-II is a **correct** explanation for Statement-I.
 (2) Statement-I is true; Statement-II is true; Statement-II is **not** a correct explanation for Statement-I.
 (3) Statement-I is true; Statement-II is false.
 (4) Statement-I is false; Statement-II is true.

Sol.

(2)

Let common tangent

$$y = mx + \frac{\sqrt{5}}{m}$$

$$\frac{\frac{\sqrt{5}}{m}}{\sqrt{1+m^2}} = \frac{\sqrt{5}}{2}$$

$$m\sqrt{1+m^2} = \sqrt{2}$$

$$m^2(1+m^2) = 2$$

$$m^4 + m^2 - 2 = 0$$

$$(m^2 + 2)(m^2 - 1) = 0$$

$$m = \pm 1$$

$y = \pm (x + \sqrt{5})$, both statements are correct as $m = \pm 1$ satisfies the given equation of statement-2.

88. If $y = \sec(\tan^{-1}x)$, then $\frac{dy}{dx}$ at $x = 1$ is equal to :

(1) $\frac{1}{\sqrt{2}}$

(2) $\frac{1}{2}$

(3) 1

(4) $\sqrt{2}$

Sol. (1)

$$y = \sec(\tan^{-1}x)$$

Let $\tan^{-1}x = \theta$

$$x = \tan \theta$$

$$y = \sec \theta$$

$$y = \sqrt{1+x^2}$$

$$\frac{dy}{dx} = \frac{1}{2\sqrt{1+x^2}} \cdot 2x$$

at $x = 1$

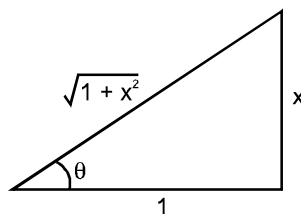

$$\frac{dy}{dx} = \frac{1}{\sqrt{2}}$$

89. The expression $\frac{\tan A}{1 - \cot A} + \frac{\cot A}{1 - \tan A}$ can be written as :

- (1) $\sin A \cos A + 1$ (2) $\sec A \operatorname{cosec} A + 1$
 (3) $\tan A + \cot A$ (4) $\sec A + \operatorname{cosec} A$

Sol. (2)
 Given expression

$$\begin{aligned} &= \frac{\sin A}{\cos A} \times \frac{\sin A}{\sin A - \cos A} + \frac{\cos A}{\sin A} \times \frac{\cos A}{\cos A - \sin A} \\ &= \frac{1}{\sin A - \cos A} \left\{ \frac{\sin^3 A - \cos^3 A}{\cos A \sin A} \right\} \\ &= \frac{\sin^2 A + \sin A \cos A + \cos^2 A}{\sin A \cos A} = 1 + \sec A \operatorname{cosec} A \end{aligned}$$

90. All the students of a class performed poorly in Mathematics. The teacher decided to give grace marks of 10 to each of the students. Which of the following statistical measures will not change even after the grace marks were given ?

- (1) mean (2) median (3) mode (4) variance

Sol. (4)

If initially all marks were x_i then $\sigma_1^2 = \frac{\sum (x_i - \bar{x})^2}{N}$

Now each is increased by 10

$$\sigma_2^2 = \frac{\sum [(x_i + 10) - (\bar{x} + 10)]^2}{N} = \sigma_1^2$$

So variance will not change whereas mean, median and mode will increase by 10.